

## Features

- Low Forward Voltage Drop
- Fast Switching Time
- Surface Mount Package Ideally Suited for Automated Insertion
- **Lead, Halogen and Antimony Free, RoHS Compliant "Green" Device (Notes 3 and 4)**

## Mechanical Data

- Case: SOD-123
- Case Material: Molded Plastic. UL Flammability Classification Rating 94V-0
- Moisture Sensitivity: Level 1 per J-STD-020D
- Terminals: Solderable per MIL-STD-202, Method 208
- Lead Free Plating (Matte Tin Finish annealed over Alloy 42 leadframe).
- Polarity: Cathode Band
- Marking Information: See Page 2
- Ordering Information: See Page 2
- Weight: 0.01 grams (approximate)



Top View

## Maximum Ratings @ $T_A = 25^\circ\text{C}$ unless otherwise specified

| Characteristic                            | Symbol       | Value | Unit |
|---|--------------|-------|------|
| Peak Repetitive Reverse Voltage           | $V_{RRM}$    | 30    | V    |
| Working Peak Reverse Voltage              | $V_{RWM}$    |       |      |
| DC Blocking Voltage                       | $V_R$        |       |      |
| RMS Reverse Voltage                       | $V_{R(RMS)}$ | 21    | V    |
| Forward Continuous Current (Note 1)       | $I_{FM}$     | 200   | mA   |
| Repetitive Peak Forward Current (Note 1)  | $I_{FRM}$    | 500   | mA   |
| Non-Repetitive Peak Forward Surge Current | $I_{FSM}$    | 4.0   | A    |

## Thermal Characteristics

| Characteristic                                      | Symbol          | Value       | Unit                      |
|---|-----------------|-------------|---------------------------|
| Power Dissipation                                   | $P_D$           | 200         | mW                        |
| Thermal Resistance Junction to Ambient Air (Note 1) | $R_{\theta JA}$ | 500         | $^\circ\text{C}/\text{W}$ |
| Operating and Storage Temperature Range             | $T_J, T_{STG}$  | -55 to +125 | $^\circ\text{C}$          |

## Electrical Characteristics @ $T_A = 25^\circ\text{C}$ unless otherwise specified

| Characteristic                     | Symbol      | Min  | Max  | Unit          | Test Condition  |
|------------------------------------|-------------|------|------|---------------|---|
| Reverse Breakdown Voltage (Note 2) | $V_{(BR)R}$ | 30   | —    | V             | $I_R = 100\mu\text{A}$  |
| Forward Voltage Drop               | $V_{FM}$    | —    | 1.0  | V             | $I_F = 200\text{mA}$  |
|                                    |             | —    | 0.40 |               | $I_F = 10\text{mA}$   |
|                                    |             | —    | 0.65 |               | $I_F = 50\text{mA}$   |
|                                    |             | 0.26 | 0.33 |               | $I_F = 2.0\text{mA}$  |
|                                    |             | —    | 0.45 |               | $I_F = 15\text{mA}$   |
| Peak Reverse Current (Note 2)      | $I_{RM}$    | —    | 500  | nA            | $V_R = 25\text{V}$  |
|                                    |             |      | 100  | $\mu\text{A}$ | $V_R = 25\text{V}, T_J = 100^\circ\text{C}$                         |
| Total Capacitance                  | $C_T$       | —    | 10   | pF            | $V_R = 1.0\text{V}, f = 1.0\text{MHz}$                              |
| Reverse Recovery Time              | $t_{rr}$    | —    | 5.0  | ns            | $I_F = I_R = 10\text{mA}, I_{rr} = 0.1 \times I_R, R_L = 100\Omega$ |

- Notes:
1. Part mounted on FR-4 board with recommended pad layout, which can be found on our website at <http://www.diodes.com/datasheets/ap02001.pdf>.
  2. Short duration pulse test used to minimize self-heating effect.
  3. No purposefully added lead. Halogen and Antimony Free.
  4. Product manufactured with Data Code V9 (week 33, 2008) and newer are built with Green Molding Compound. Product manufactured prior to Date Code V9 are built with Non-Green Molding Compound and may contain Halogens or  $\text{Sb}_2\text{O}_3$  Fire Retardants.

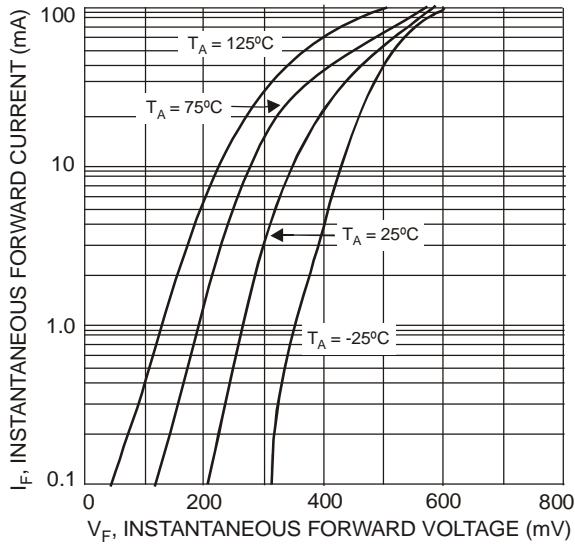

Fig. 1 Typical Forward Characteristics

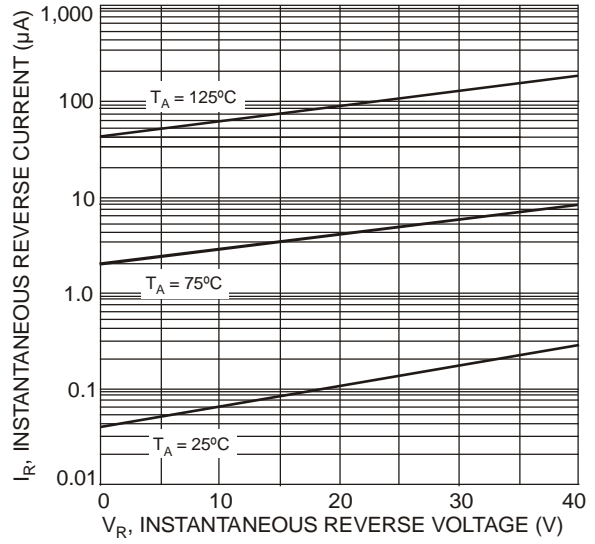

Fig. 2 Typical Reverse Characteristics

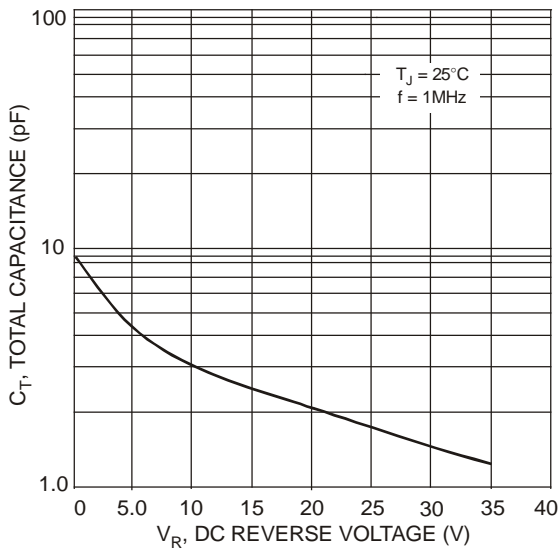

Fig. 3 Total Capacitance vs. Reverse Voltage

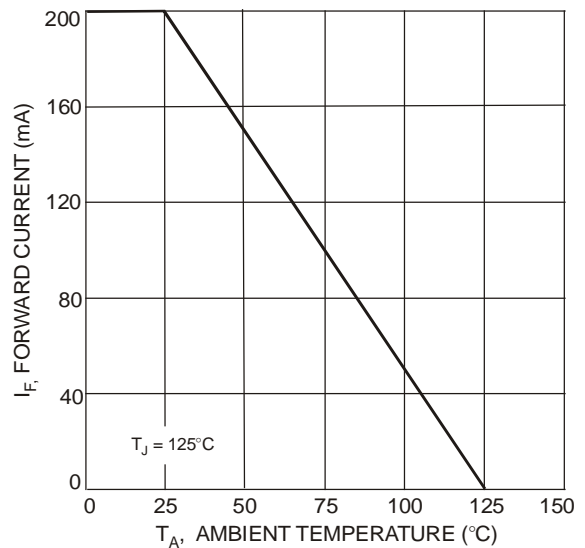

Fig. 4 Forward Current Derating Curve

**Ordering Information** (Note 5)

| Part Number | Case    | Packaging        |
|-------------|---------|------------------|
| BAT42W-7-F  | SOD-123 | 3000/Tape & Reel |
| BAT43W-7-F  | SOD-123 | 3000/Tape & Reel |

Notes: 5. For packaging details, go to our website at <http://www.diodes.com/datasheets/ap02007.pdf>.

**Marking Information**

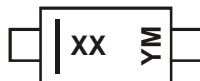

xx = Product Type Marking Code  
 S7 = BAT42W  
 S8 = BAT43W  
 YM = Date Code Marking  
 Y = Year (ex: N = 2002)  
 M = Month (ex: 9 = September)

Date Code Key

| Year  | 2001 | 2002 | 2003 | 2004 | 2005 | 2006 | 2007 | 2008 | 2009 | 2010 | 2011 | 2012 | 2013 | 2014 | 2015 |
|-------|------|------|------|------|------|------|------|------|------|------|------|------|------|------|------|
| Code  | M    | N    | P    | R    | S    | T    | U    | V    | W    | X    | Y    | Z    | A    | B    | C    |
| Month | Jan  | Feb  | Mar  | Apr  | May  | Jun  | Jul  | Aug  | Sep  | Oct  | Nov  | Dec  |      |      |      |
| Code  | 1    | 2    | 3    | 4    | 5    | 6    | 7    | 8    | 9    | O    | N    | D    |      |      |      |

**Package Outline Dimensions**

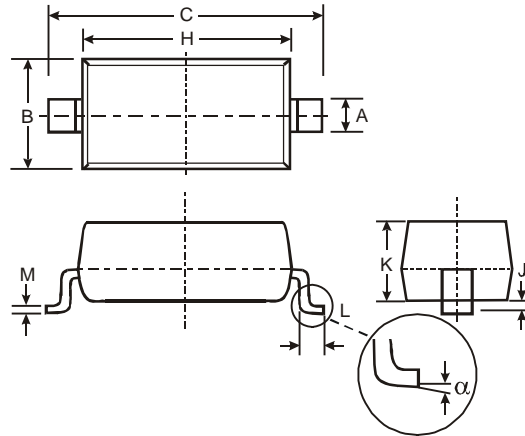

| SOD-123              |          |      |
|----------------------|----------|------|
| Dim                  | Min      | Max  |
| A                    | 0.55 Typ |      |
| B                    | 1.40     | 1.70 |
| C                    | 3.55     | 3.85 |
| H                    | 2.55     | 2.85 |
| J                    | 0.00     | 0.10 |
| K                    | 1.00     | 1.35 |
| L                    | 0.25     | 0.40 |
| M                    | 0.10     | 0.15 |
| $\alpha$             | 0        | 8°   |
| All Dimensions in mm |          |      |

**Suggested Pad Layout**

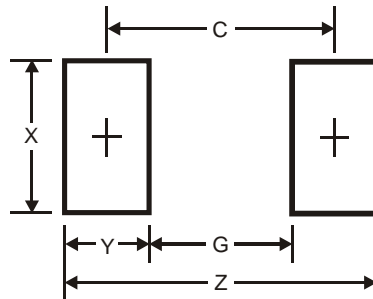

| Dimensions | Value (in mm) |
|------------|---------------|
| Z          | 4.9           |
| G          | 2.5           |
| X          | 0.7           |
| Y          | 1.2           |
| C          | 3.7           |

**IMPORTANT NOTICE**

Diodes Incorporated and its subsidiaries reserve the right to make modifications, enhancements, improvements, corrections or other changes without further notice to any product herein. Diodes Incorporated does not assume any liability arising out of the application or use of any product described herein; neither does it convey any license under its patent rights, nor the rights of others. The user of products in such applications shall assume all risks of such use and will agree to hold Diodes Incorporated and all the companies whose products are represented on our website, harmless against all damages.

**LIFE SUPPORT**

Diodes Incorporated products are not authorized for use as critical components in life support devices or systems without the expressed written approval of the President of Diodes Incorporated.